



EZ38

Tracked Zero Tail Excavators



EZ38 - expands your leeway for working.

The highly comfortable interior completes the concept of Zero Tails in a unique way. Whether with the completely revised cabin or the modified hydraulics, the new EZ models will also convince you in everyday work on the construction site.

- Cabin and canopy impress with an ergonomic design for more comfort, precision and productivity.
- A large volume diesel engine and an efficient hydraulics system permit working at full load in surrounding temperatures of up to 45 °C.
- The compact dimensions and the robust design make the new EZ models extremely maneuverable and compact machines with long, useful lives.
- Maximum connection options with up to 3 auxiliary control circuits.
- Optional Vertical Digging System (VDS) and Easy Lock.



Technical specifications

Operating data

Shipping weight min.	3,582 kg
Operating weight	3,753 - 4,474 kg
Biting force max.	17.8 kN
Breakout force max.	32 kN
Digging depth max.	3,357 mm
Dumping height	3317 - 3516 mm
Dump height max.	3,516 mm
Digging radius max.	5,535 mm
Superstructure slewing speed	8.8 1/min
L x W x H	4800 x 1740 x 2500 mm

Engine / Motor

Engine / Motor manufacturer	Yanmar
Engine / Motor type	3TNV88
Engine / Motor	Water-cooled 3-cylinder diesel engine
Displacement	1,642 cm ³
RPM / speed	2,400 rpm
Engine performance acc. to ISO	21.4 kW
Battery	74 Ah
Tank capacity	44 l

Hydraulic system

Duty pump	Double variable- & two-gear pump
Flow rate	40 l/min
Operating pressure for working and traction hydraulics	240 bar
Operating pressure Slewing gear	210 bar
Hydraulic oil tank	38.5 l

Undercarriage

Travel speed max.	4.3 km/h
Chain width	300 mm
Ground clearance	280 mm

Dozer Blade

Width	1,740 mm
Height	345 mm
Stroke max., above ground	387 mm



**WACKER
NEUSON**
all it takes!

Stroke max., below ground	450 mm
Sound level	
Sound level (LWA) acc. to 2000/14/EC	95 dB(A)
Cabin - specified sound pressure level LpA acc. to ISO 6394	77 dB(A)



Dimensions

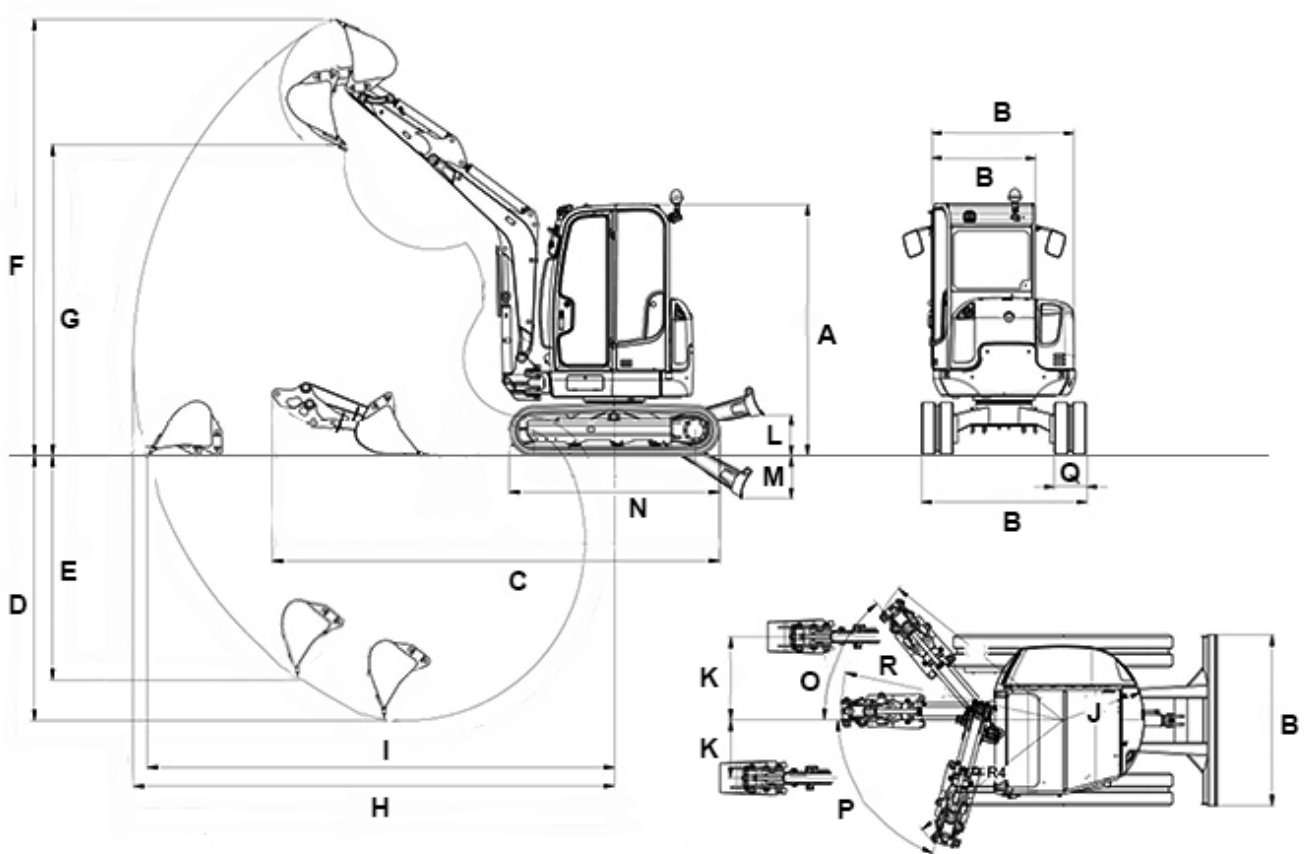

VDS

A	Height	2,500 mm	2,568 mm
B	Width of the cabin	990 mm	990 mm
B	Width of the revolving superstructure	1,600 mm	1,600 mm
B	Width of the undercarriage	1,740 mm	1,740 mm
C	Transport length (short dipper arm)	4,799 mm	4,747 mm
C	Transport length (long dipper arm)	4,823 mm	4,792 mm
D	Digging depth max. Max. (short dipper arm)	3,107 mm	3,034 mm
D	Digging depth max. Max. (long dipper arm)	3,357 mm	3,284 mm
E	Insertion depth Max. vertical (short dipper arm)	2,385 mm	2,311 mm



E	Insertion depth Max. vertical (long dipper arm)	2,625 mm	2,551 mm
F	Insertion height Max. (short dipper arm)	4,529 mm	4,597 mm
F	Insertion height Max. (long dipper arm)	4,658 mm	4,727 mm
G	Dump height max. Max. (short dipper arm)	3,317 mm	3,387 mm
G	Dump height max. Max. (long dipper arm)	3,446 mm	3,516 mm
H	Digging radius max. Max. (short dipper arm)	5,300 mm	5,297 mm
H	Digging radius max. Max. (long dipper arm)	5,535 mm	5,532 mm
I	Range Max. ground coverage (short dipper arm)	5,192 mm	5,134 mm
I	Range Max. ground coverage (long dipper arm)	5,431 mm	5,348 mm
J	Rear swivel radius	870 mm	870 mm
K	Arm displacement Max. boom offset to center of bucket, right side	740 mm	740 mm
K	Arm displacement Max. boom offset to center of bucket, left side	589 mm	589 mm
L	Lift height Max. of dozer blade above subgrade	387 mm	377 mm
M	Scraping depth Max. of the dozer blade below subgrade	450 mm	460 mm
N	Length	2,056 mm	2,056 mm
O	Turning angle Max. of the arm system to the right	54.7 °	54.7 °
P	Turning angle Max. of the arm system to the left	70 °	70 °
--	Distance of bucket dozer blade (short dipper arm)	261 mm	238 mm
--	Distance of bucket dozer blade (long dipper arm)	123 mm	101 mm
R	Boom slewing radius center	2,377 mm	2,377 mm
--	Boom slewing radius right	2,219 mm	2,219 mm
--	Boom slewing radius left	1,983 mm	1,983 mm
--	Length Total traveling gear	2,056 mm	2,056 mm
--	Width Dozer blade	1,740 mm	1,740 mm



**WACKER
NEUSON**
all it takes!

-- Height Dozer blade

355 mm

355 mm

Please note

that product availability can vary from country to country. It is possible that information / products may not be available in your country. More detailed information on engine power can be found in the operator's manual; the stated power may vary due to specific operating conditions.

Subject to alterations and errors excepted. Applicable also to illustrations.

Copyright © 2018 Wacker Neuson SE.